

Sumner  
Tools

12

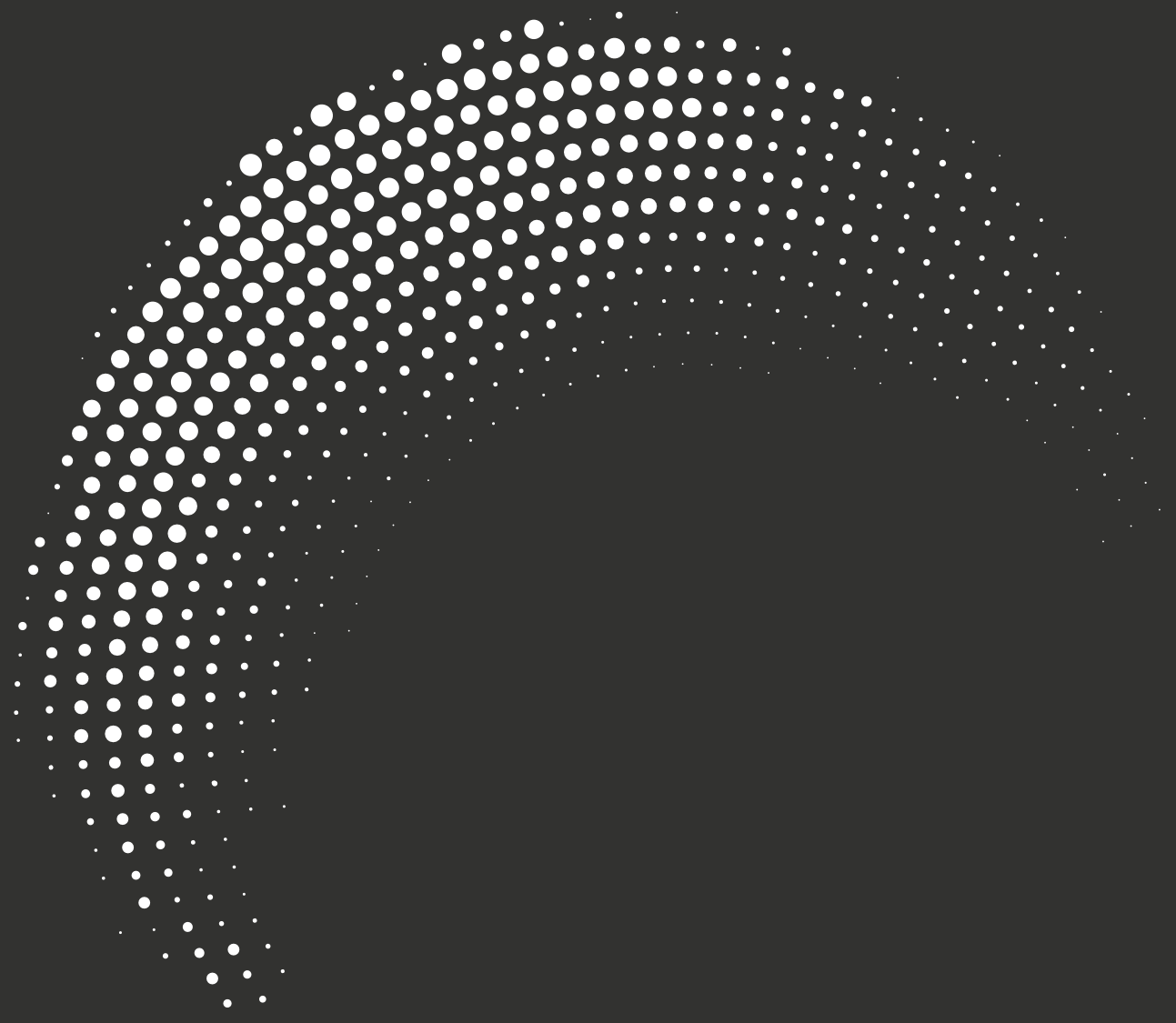



# Contents

---

<b>Pipe Trolley</b>	
Cricket Pipe Trolley	380
<b>Jacks</b>	
Hi Pro-Jack	381
Hi Heavy Duty Jack	381
Hi Fold-A-Jack	381
<b>Jacks Heads &amp; Accessories</b>	382
<b>Large Jacks</b>	
Hi Boy Jack Stand	383
Max Jax	383
Big Vee Jack	384
Vee Heads	384
<b>Roller Heads</b>	
Pro Roll	385
Adjust-A-Roll	385
Quick Change Roller Heads Choices	385
<b>Pipe Fitting Tools</b>	
Internal Fit-Up Clamps	386
Hold-Down Device	386
Rotary Earth Clamp	387
Adjust-A-Flange	387
Adjust-A-Fit	387
Flange Pins & Leveller	387
<b>Clamps</b>	
Ultra Qwik Clamps	388

## Cricket Pipe Trolley

More than a pipe trolley – uses leverage to lift pipes

- Ideal for carrying flanges, fittings and valves
- Transport 6.1m pipe lengths up to 450kg
- Supplied with ratchet hold-down strap and 16" pneumatic tyres
- Weighs just 37.2kg
- Quick handle disconnect for compact storage
- Flat free tyres



Replacement Wheels:  
**779107** – Pneumatic  
**779104** – Flat Free

Summer  
Tools



1. Use ratchet to secure Cricket to pipe



2. Use ratchet to flip Cricket and pipe



3. Reposition handle

Part No.	Description	Height	Width	Width between wheels	Length	Weight
<b>782685</b>	Cricket with flat free tyres	53cm	71cm	41cm	71cm	37.2kg

## Hi Pro-Jack



- Formed steel legs
- 1135kg load capacity
- Strut tension plate for superior lateral support
- Quick action lock washer
- Height: Maximum 125 cm  
Minimum 71 cm

**FALL  
GUARD™**

Patented Fall Guard™ feature allows 25mm safety zone around lock washer

Part No.	Description	Weight
<b>780311</b>	Hi Pro-Jack - base assembly Height: 710-1250mm	6.3kg

**HEAD NOT SUPPLIED – for choice of head options see opposite**

## Hi Heavy Duty Jack



- Replaceable legs
- Tough 25mm square tube base construction
- 1135kg load capacity
- Strut tension plate for superior lateral support
- Quick action lock washer
- Built for heavy use and abuse!

**FALL  
GUARD™**

Patented Fall Guard™ feature allows 25mm safety zone around lock washer

Part No.	Description	Weight
<b>780523</b>	Hi Heavy Duty Jack – base assembly Height: 710-1250mm	6.8kg

**HEAD NOT SUPPLIED – for choice of head options see opposite**

## Hi Fold-A-Jack



- Folds up for easy storage
- 25mm square tube base construction
- 1135kg capacity
- Quick action lock washer
- Height: Maximum 125 cm  
Minimum 71 cm

**FALL  
GUARD™**

Patented Fall Guard™ feature allows 25mm safety zone around lock washer





Part No.	Description	Weight
<b>780312</b>	Hi Fold-A-Jack – base assembly Height: 710-1250mm	6.3kg

**HEAD NOT SUPPLIED – for choice of head options see opposite**



## a choice of 5 head styles for every application



	Vee Head	Ball Transfer Head*	Steel Roller Head	Rubber Roller Head	Bar Stock Head
					
<b>Pro Jack capacity</b>	1135kg	450kg	900kg	450kg	900kg
<b>Fold-A-Jack capacity</b>	1135kg	450kg	900kg	450kg	900kg
<b>Heavy Duty Jack capacity</b>	1135kg	450kg	900kg	450kg	900kg
<b>Pipe size</b>	3-600mm	10-300mm	30-600mm	40-600mm	3-250mm
<b>Application</b>	General welding of pipe shapes, solids and rounds	Rotation of pipe or tubing in all directions	Welding of pipe and rounds	Non-marring surface, roll welding of pipes and rounds	Welding of flats and shapes

### Jack Parts & Accessories

Part No.	Description	Stainless Steel Vee-Head Attachment
<b>780330</b>	Setscrew (set of 6)	Fits over vee and secures with two bolts – no tools required!
<b>780333</b>	Lockwasher (set of 6)	
<b>780422</b>	Lo ID Barrel	
<b>780424</b>	Hi ID Barrel	



Part No. **780502**

### Spare Heads for Stands

Part No.	Description	Weight
<b>780305</b>	Vee-Head	4.2kg
<b>780551</b>	Ball Transfer Head (mild steel)*	3.0kg
<b>780274</b>	Ball Transfer Head (stainless steel)*	3.0kg
<b>780307</b>	Roller Head (mild steel)	5.7kg
<b>780308</b>	Roller Head (stainless steel)	5.9kg
<b>780309</b>	Roller Head with Rubber Wheels	5.0kg
<b>780310</b>	Bar Stock Head	4.5kg

\*Requires 780305 Vee-Head – supplied separately.

## Hi Boy Jack Stand



The Hi Boy is a tall jack specifically designed for tight pipe installation such as in mechanical rooms or tunnels.

The Hi Boy is a safe, portable folding stand that is easy to transport and holds up to a hefty 450kg. In its lowest position at 98cm and its highest at 180cm, the Hi Boy is ideal for everyday fabrication of weld pipe. Legs fold up for convenient storage in job boxes or truck beds.

Part No.	Description	Weight
<b>783250</b>	Hi Boy Jack Stand	20.4kg

## Max Jax



Part No. **781464** Five 203mm heavy duty casters make up the Max Jax Caster Kit. The rubber casters have a quick action braking system.

The versatile Sumner Max Jax is the ideal fabricator stand. The large 305mm vee head and heavy duty 5-leg design offers the welder an extra margin of safety on pipes up to 900mm diameter.

- Sturdy 3-leg construction for greater stability
- 100-900mm diameter pipe capacity
- 1135kg load capacity

### SPECIFICATIONS

Load capacity		1135 kg
Basic Unit	<b>A</b> Height	686 mm
	<b>B</b> Width	752 mm
Basic Unit with Casters	Height	927 mm
	Width	1003 mm
Vee-Head height	<b>C</b> Min	533 mm
	<b>C</b> Max	838 mm
Vee-Head height with Casters	Min	775 mm
	Max	1080 mm

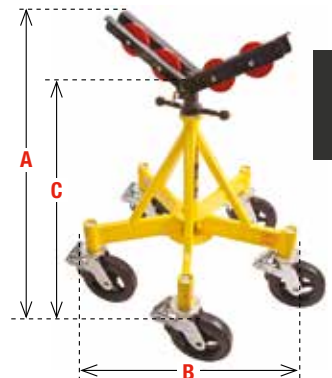

Part No.	Description	Weight
<b>781460</b>	Max Jax c/w Vee Head (basic)	26.4kg

For head options – see page 000

## Big Vee Jack



The Sumner Big Vee Jack is ideal for fabricators of large diameter pipes. With a wider base, 45mm Acme adjustment screw and greater load capacity, the Big Vee is the ideal stand for this application. The heavy duty 3-leg stand is built tough enough for the demands of larger pipes.

- Heavy duty 25mm square leg tubing can support
- Quick and precise height adjustment
- 1135kg loads
- Wide base for extra stability
- Takes up to 914mm diameter pipe
- Optional roller wheels

### SPECIFICATIONS

Load capacity		1135 kg
Basic Unit	A	Height 902 mm
	B	Width 749 mm
Vee-Head height	C	Min 749 mm
	C	Max 1041 mm

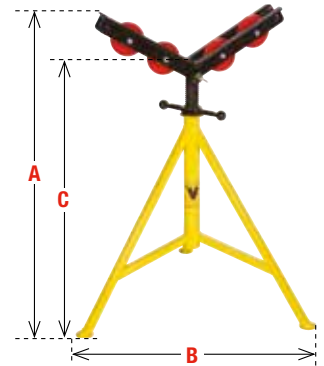

Part No.	Description	Weight
<b>780260</b>	Big Vee Jack (basic) with Vee head	16.4kg

## Vee Heads

### 781406\*

Steel Roller Head Kit  
Weight: 4.1kg



### 781383\*

Standard Ball Transfer Kit  
Weight: 2.3kg



### 781407\*

Stainless Steel Roller Head Kit  
900kg capacity  
Weight: 4.1kg



### 781397\*

Stainless Steel Ball Transfer Kit  
450kg capacity  
Weight: 2.3kg



### 781381\*

Large Roller Wheel Kit  
Weight: 15.5kg



### 781382\*

Stainless Steel Sleeves  
Weight: 2.3kg



### 781394\*

Rubber Wheel Kit  
450kg capacity  
Weight: 1.8kg



\*Vee head for illustration purposes only



## Pro Roll



Pro Roll shown with Steel Wheels

- Holds up to 914mm pipe
- Levelling on either side of stand
- Easily adjustable height (see diagram)
- Maximum capacity 1135kg

Easily adjustable height on Pro Roll

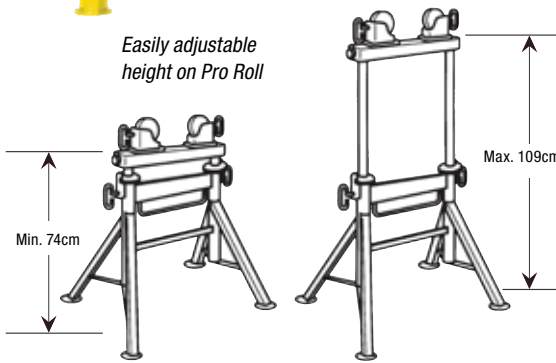

Part No.	Description	Weight
<b>780440</b>	Pro Roll – Base Only	16.4kg

**HEAD NOT SUPPLIED** – for choice of head options see below

## Adjust-A-Roll



Adjust-A-Roll with Bar Stock Head

- Fixed Height 77.5cm
- Maximum capacity 1135kg

Part No.	Description	Weight
<b>780399</b>	Adjust-A-Roll – Base Only	10.9kg

**HEAD NOT SUPPLIED** – for choice of head options see below

## Table Adjust-A-Roll



Table Adjust-A-Roll with Ball Transfer Head

Part No.	Description	Weight
<b>780500</b>	Table Adjust-A-Roll – Base Only	10.9kg

**HEAD NOT SUPPLIED** – for choice of head options see below

## Quick Change Roller Heads Choices

Sumner's innovative Quick Change Roller Housings increase the utility of its roller stands. Roller housings can be changed with ease, without tools, to adapt to changing job requirements. Roller wheels are available in steel, stainless steel or rubber. Bar stock and ball transfer heads (with carbon or stainless steel balls) are also available.

Part No.	Description	Cap. Weight	Weight
<b>783151</b>	Steel Wheels (set of 2)	1130kg	3.6kg
<b>783152</b>	Rubber Wheels (set of 2)	550kg	3.2kg
<b>783153</b>	Stainless Steel Wheels (set of 2)	1130kg	3.6kg
<b>783154</b>	Ball Transfer Head (set of 2)	450kg	3.2kg
<b>783155</b>	Bar Stock Head	900kg	7.2kg
<b>783159</b>	Stainless Steel Ball Transfer Head (set of 2)	450kg	10.5kg



## Internal Fit-Up Clamps



**784100**  
50-145mm

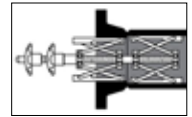

*Two independently operated internal clamps align flange to pipe, even if internal dimensions differ*



**784102**  
100-220mm

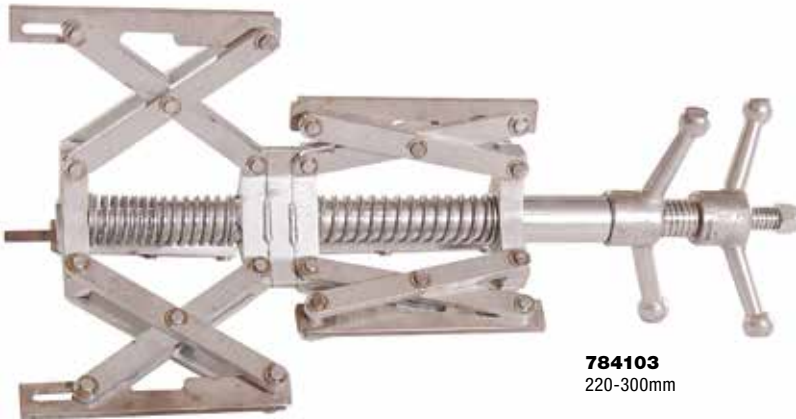

**784103**  
220-300mm

## Hold-Down Device

**Holds pipe or shape up to 305mm diameter**

- Similar in operation to a chain vice for pipe, the Hold-Down Device uses high tensile strength chain to grip material in any Sumner vee-head jack
- Ideal for fitting up flanges, fittings or valves and a must when working with short lengths
- Can be used with both standard and large vee-head jacks



Part No.	Description	Weight
<b>781050</b>	Hold-Down Device	3.0kg

## Rotary Earth Clamp

**780435**



## Adjust-A-Flange

**780425**



## Adjust-A-Fit

**780420**

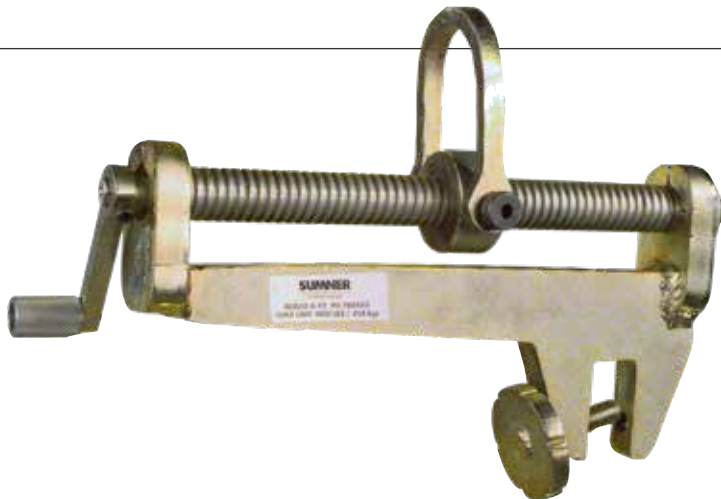

## Flange Pins & leveller

**781235**

Quick Release Steel (2)



**780429**

Stainless Steel (2)



**780430**

Steel (2)

**781240**



Automatically centres in flange holes to 16-42mm

## Ultra™ Qwik Clamps

The Sumner Ultra™ Clamp is a fast, accurate fit-up tool for pipe to pipe, pipe to fitting and other fit-up needs.



**781130**  
25-65mm / 1.6kg



**781150**  
50-150mm / 3.9kg



**781170**  
127-300mm / 6.6kg

- Push button design allows for rapid action setting and fine tune thread adjustment
- Accurate fit-up of 1" to 12" pipe
- Rugged frame, built for jobsite use
- Stainless steel alignment screws
- Operating handle repositions for close work
- Fine adjustment screws for quick fit-up
- Lightweight for overhead work
- Available in three sizes



Pipe to pipe



Pipe to flange



Pipe to tee



Pipe to fitting